

REV:	ECN. NO.	NAME	DATE

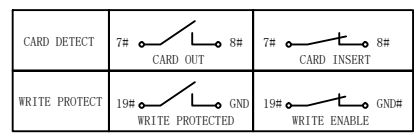
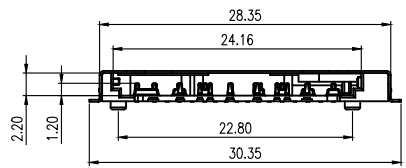
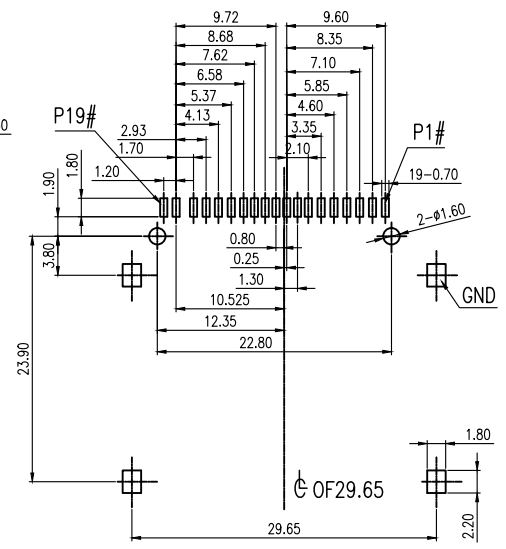
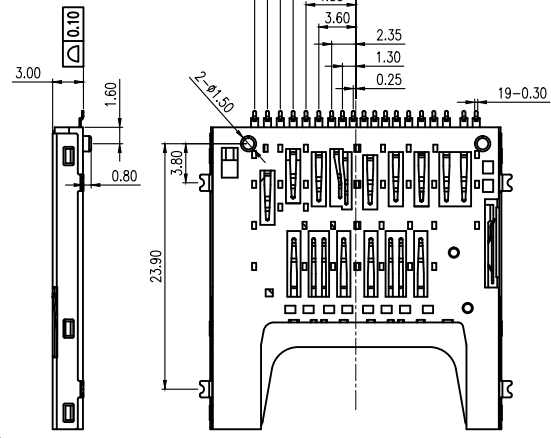
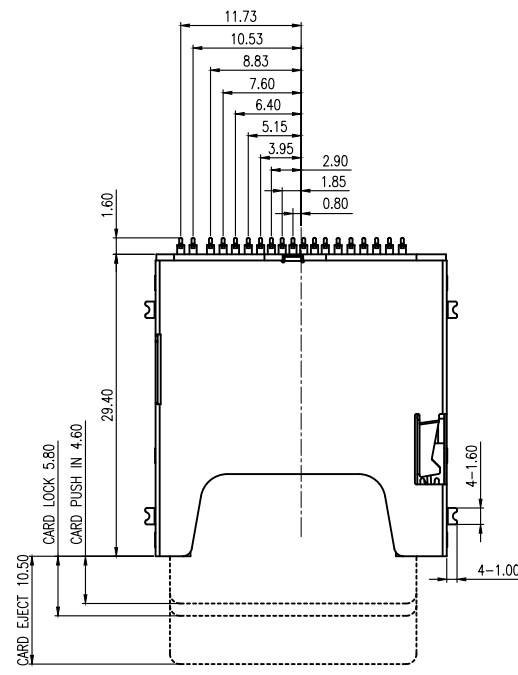

RECOMMEENDER PCB LAYOUT
TOLERANCE UNLESS OTHERWISE IS ±0.05

Specification
Material
Plastic Housing: LCP 30%GF, UL94V-0, Black
Contact Terminal: Phosphor Bronze, T=0.15mm
Cover: SUS304, T=0.2mm
Plating:
Contact Terminal
Contact Area: Gold Flash
Solder area: Tin 80u" min
Underplating: Ni overall 50u" min.
Cover: Ni overall 30u" min.
Solder area: Gold Flash
Electrical
Voltage Rating: 30V max.
Current Rating: 0.5A max.
Dielectric Withstanding Voltage: 100V AC (60 Sec min.)
Insulation Resistance: 1000 MΩ min.
Contact Resistance: 100 mΩ max.
Mechanical & Environmental
Operating Temperature: -40°C to +85°C
Durability: 5000 cycles

PIN DEFINE:

PIN#	NAME	DESCRIPTION	PIN#	NAME	DESCRIPTION
1	VSS3	GROUND	11	VDD1	SUPPLY VOLTAGE
2	DAT2	DATA LINE BIT2	12	D1-	DIFFERENTIAL DATE 1-
3	DO+	DIFFERENTIAL DATE 0+	13	CLK	CLOCK
4	CD/DAT3	CARD DETECT/DATA LINE BIT3	14	D1+	DIFFERENTIAL DATE 1+
5	D0-	DIFFERENTIAL DATE 0-	15	VSS2	SUPPLY VOLTAGE GROUND
6	CMD	COMMAND/RESPONSE	16	VSS5	GROUND
7	CD	CARD DETECT	17	DAT0	DATA LINE BIT0
8	VSS1	SUPPLY VOLTAGE GROUND	18	DAT1	DATA LINE BIT1
9	VSS4	GROUND	19	WP	WRITE PROTECT
10	VDD2	SUPPLY VOLTAGE (1.8V)			

RoHS Compliant



FOR YOUR
VITAL CONNECTION

MILLIMETERS X.° ± 2° .X ± 0.30 .XX ± 0.20 .XXX ± 0.10	INCH X.° ± 2° .X ± 0.012 .XX ± 0.008 .XXX ± 0.004	TITLE:	SD 4.0 Push H3.0 卡座	
DRAWN BY:	Zou Long	PART NO:	VTC102012552	REV: A
CHECKED BY:	Bob	SIZE: A4	UNIT:mm	SHEET:1 OF 2 FCN: E1
APPROVED BY:	QPF	PROJECTION		http://www.vitalconn.com

7		8	
REV:	ECN. NO.	NAME	DATE

A
B
C
D
E
F

A
B
C
D
E
F

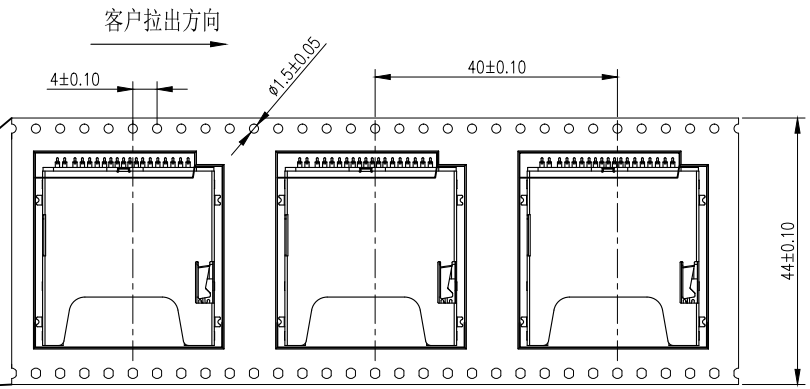

NOTES

1. 每卷包装数量:300PCS/每卷
2. 卷带包装方式:

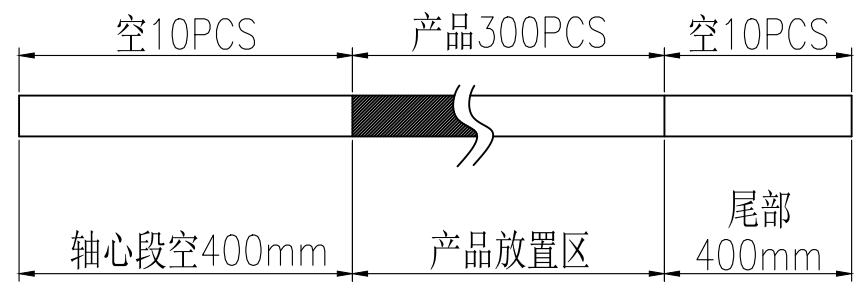

3. 每箱包装数量:1800PCS/箱

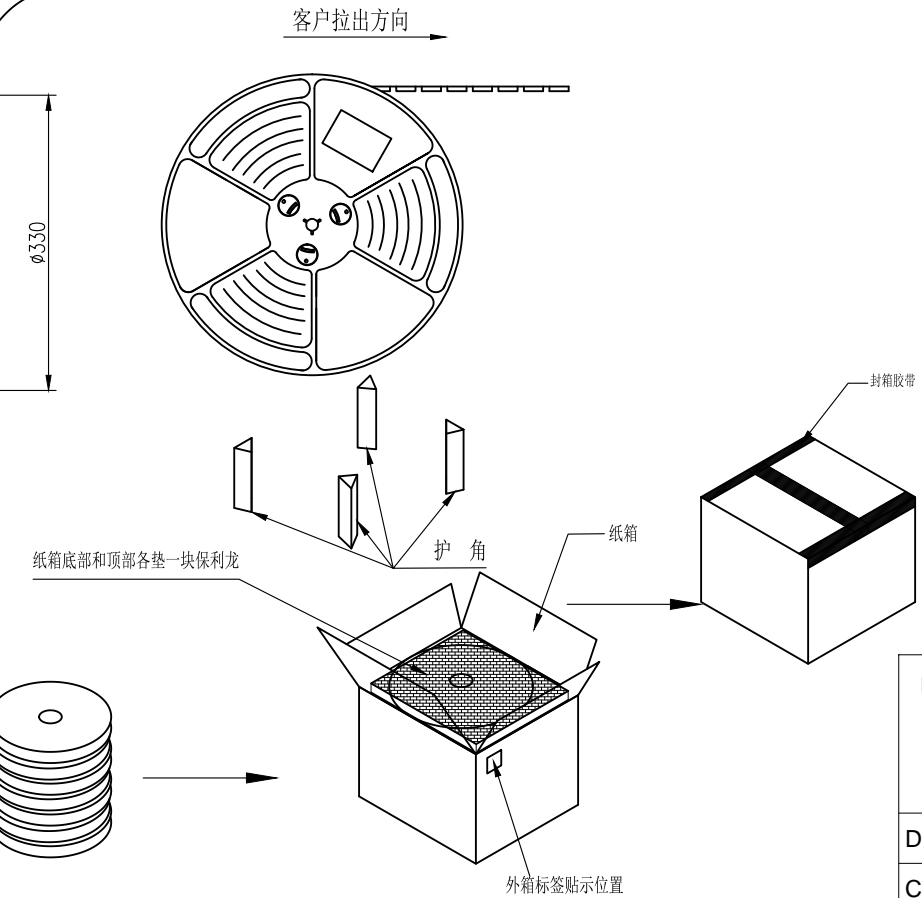

RoHS Compliant

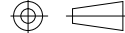
MILLIMETERS X.° ± 2° .X ± 0.30 .XX ± 0.20 .XXX ± 0.10	INCH X.° ± 2° .X ± 0.012 .XX ± 0.008 .XXX ± 0.004			FOR YOUR VITAL CONNECTION	
		TITLE: SD 4.0 Push H3.0卡座			
DRAWN BY: Zou Long		PART NO: VTC102012552		REV: A	
CHECKED BY: Bob		SIZE: A4		UNIT:mm SHEET:2 OF 2 FCN: E1	
APPROVED BY: QPF		PROJECTION 		http://www.vitalconn.com	

1 2 3 4 5 6 7 8